

# I.S.T. Vehicle installation

Individuality for your daily success

# Individuality for your daily success

We configure the vehicle equipment according to your individual requirements.  
With our technology and high-quality supply units.

## The advantages of the individual vehicle extension

- + Vehicle or trailer of choice
- + High-quality and field-tested equipment
- + Individual vehicle allocation
- + Individual design according to your corporate design

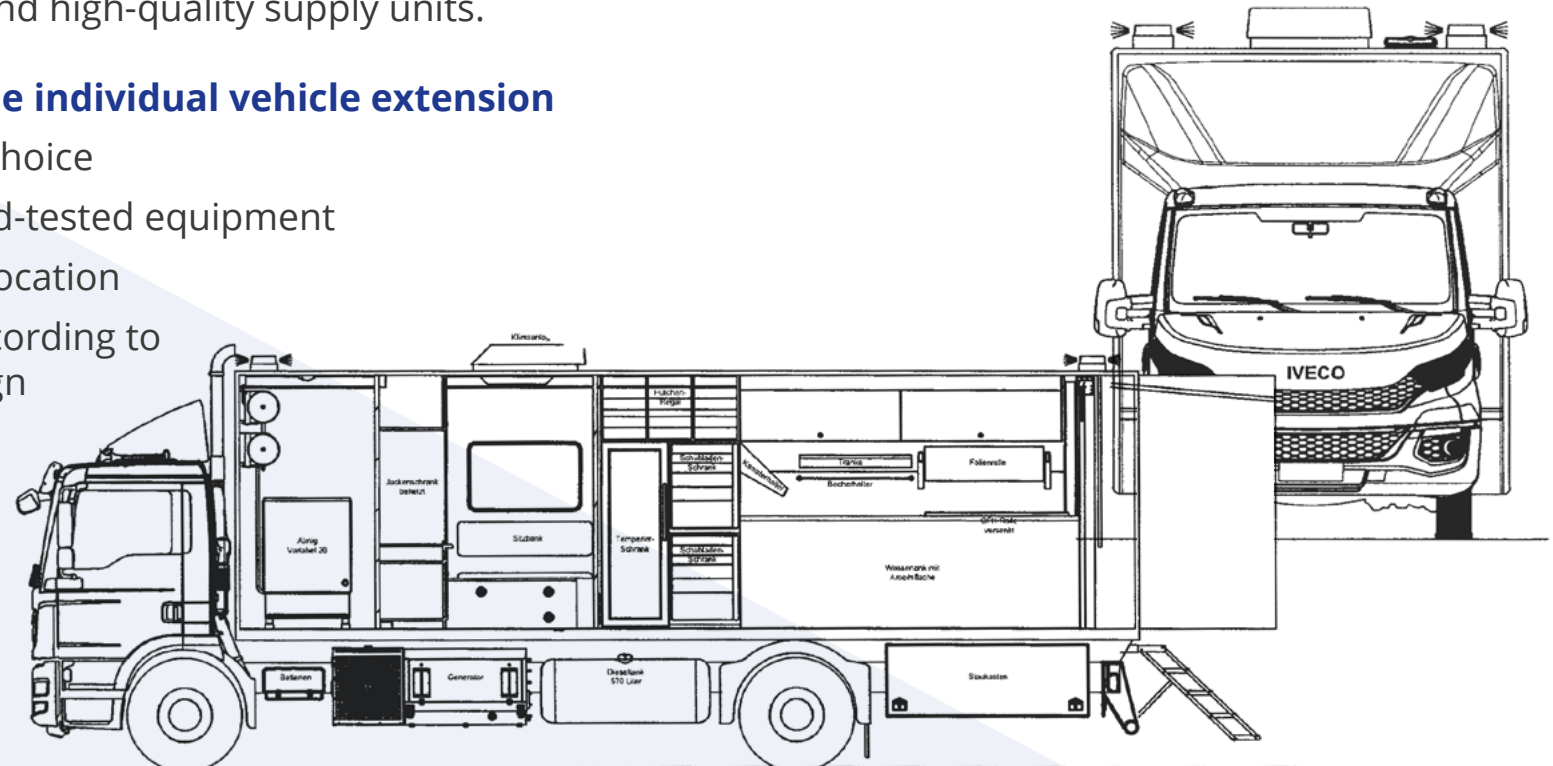

# Installation – Cutting technology

Impressions vehicle installation



## Transporter - flexible extension - minimal



With removable universal frame

## Transporter - flexible extension - minimal



Cutting vehicle Power Cutter 200



With removable universal frame

## Transporter - fixed extension - minimal

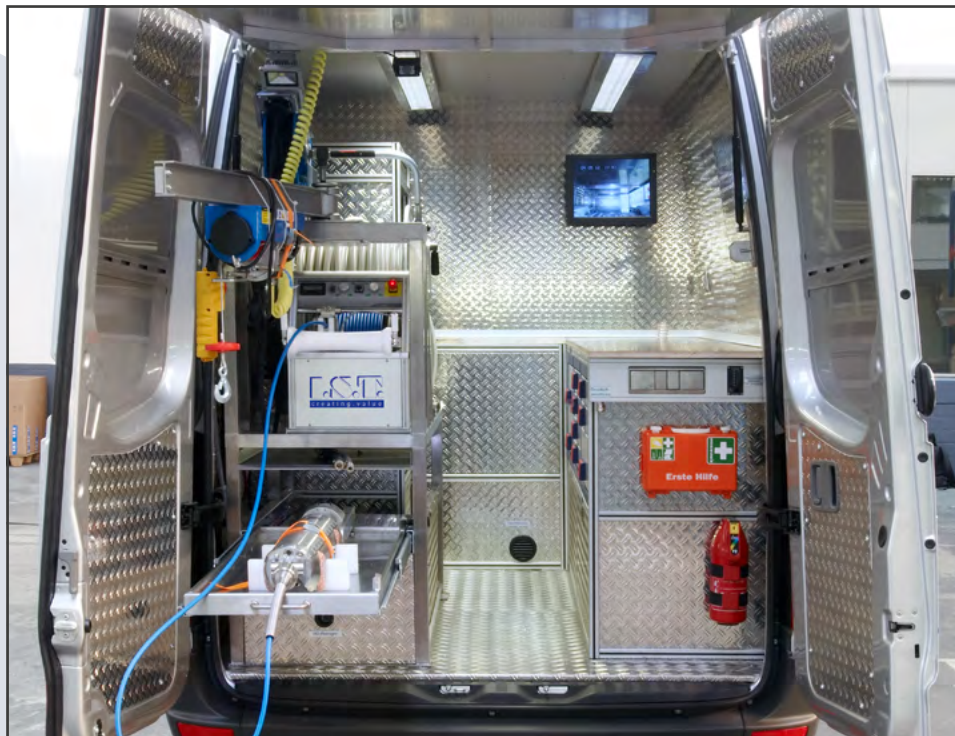

Sprinter PC 200, with manual hose reel

## Transporter - fixed extension - High-End



Iveco Sprinter

## Transporter - fixed extension - High-End



Video workplace, PC 200 with motorized hose reel



## Transporter - fixed extension - High-End



Sprinter, video workplace

# Technical drawing - Sprinter 516 CDI

With auxiliary light machine, screw compressor, PC 200 Zoom, Cable reel fully automatic with 140 m cable, Air/water drum with 100 m hose, THP control case. (Installation – Cutting technology)

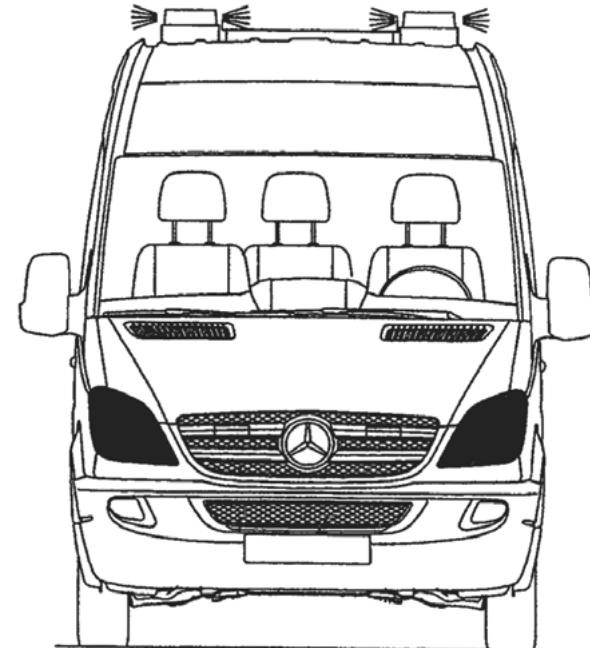
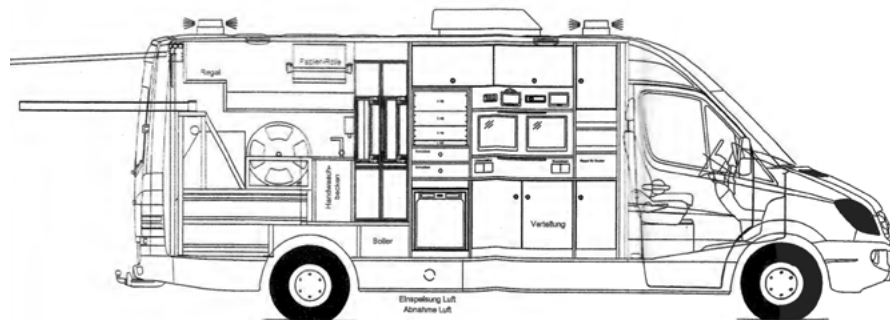
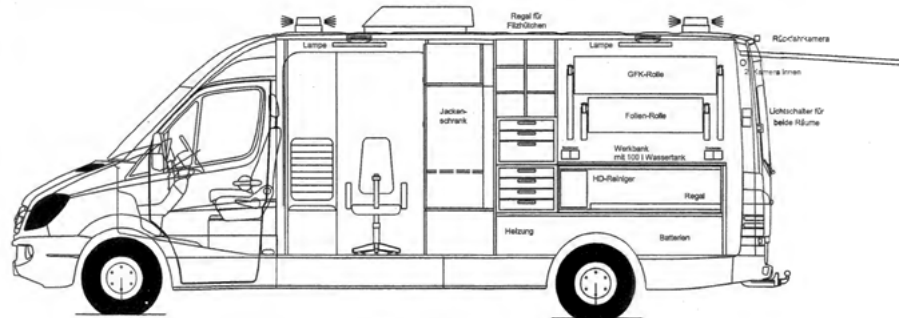

## Technical drawing - Iveco Daily 7,5

With 3500 W generator via vehicle engine, compressor, case, PC 200 Zoom, Cable drum fully automatic with 140 m cable, Air/water drum with 100 m hose, software calibration, THP control case electronic, THP system complete up to DN 600. (Installation – Cutting technology with THP)

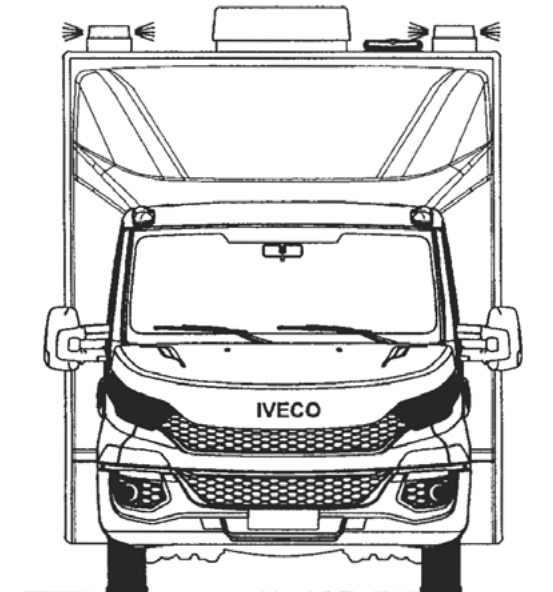
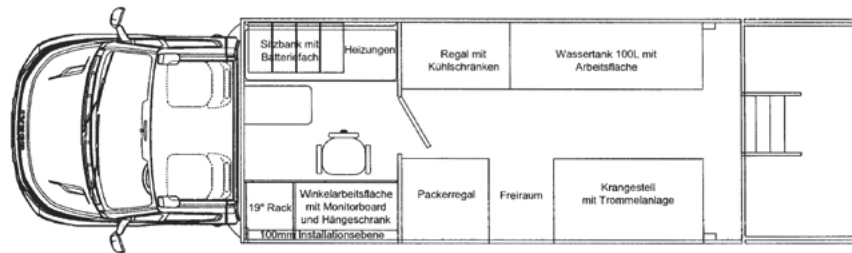
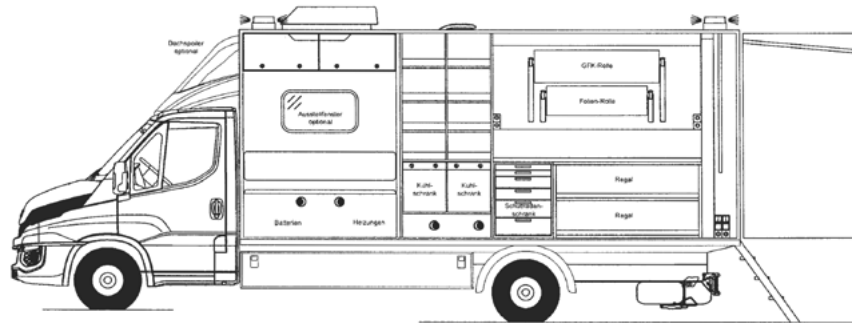

# Truck installation



Individual installation with separated aggregate compartment



# Truck installation – cutting technology with THP & flushing unit



Individual installation



Drawers and storage space

# Truck installation – cutting technology with THP & flushing unit



Individual installation



Video workplace



# Truck installation – cutting technology with THP & flushing unit



Truck 18 tons

# Truck installation – cutting technology with THP & flushing unit

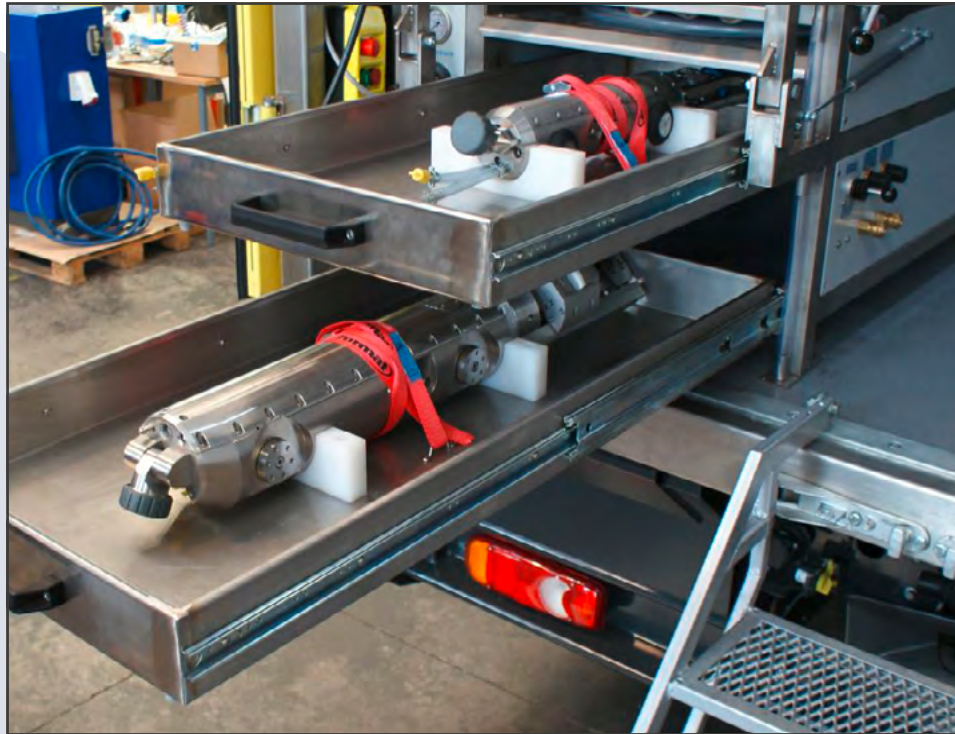

Installation – Cutting technology, universal frame drawers for robot PC150/200



Special frame with high-pressure & Power Cutter System



## Technical drawing - 18 Tons

With E-compressor, high pressure flusher incl. plastic tank 2.000 L, R 1/2" 120 m HD-hose, case, diesel generator, PC 200 Zoom, Cable drum fully automatic with 140 m cable, Air/water drum with 100 m hose, control case THP-System, PC 150 complete. (Installation – Cutting technology with THP and flushing unit)

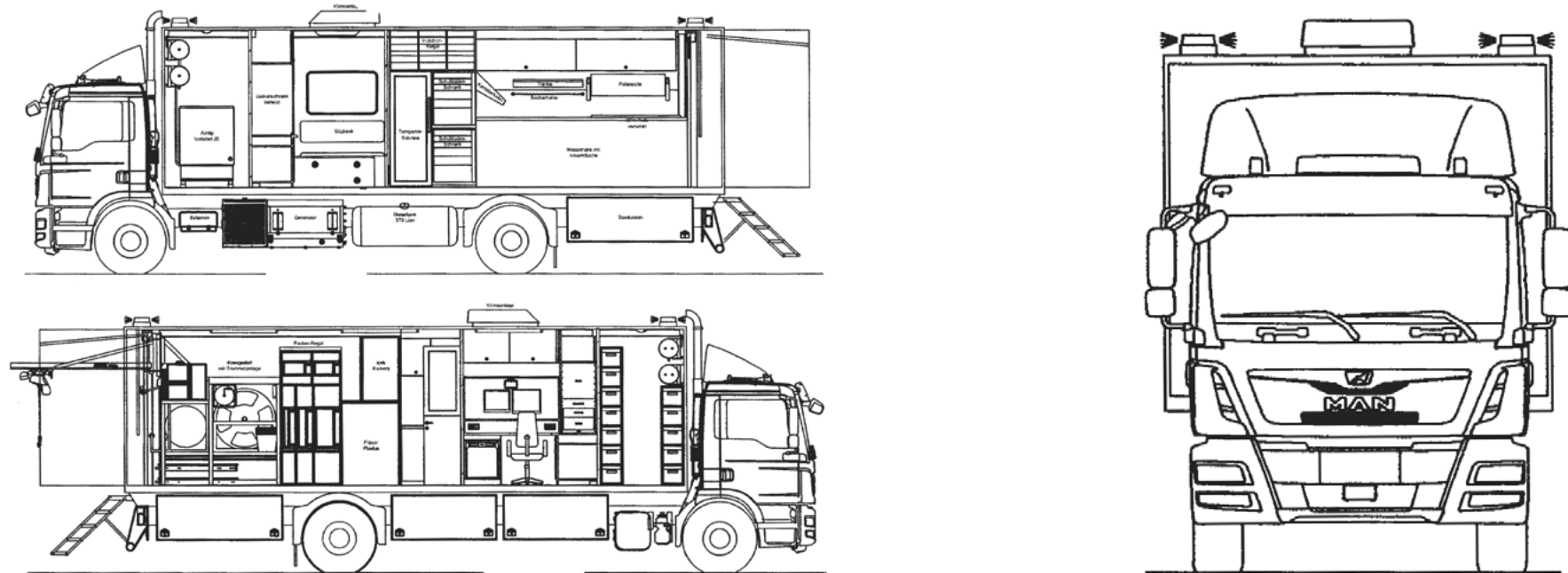

# Installation UV-technology

Impressions vehicle installation



# Truck installation - PowerLIGHT Pro

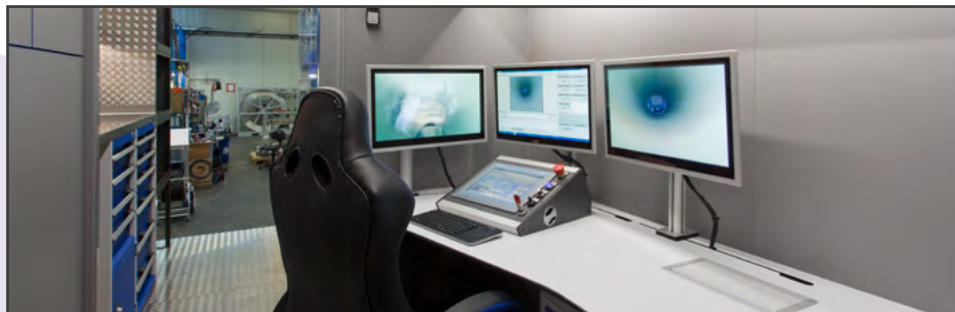

## Truck installation - PowerLIGHT Pro



Pro system with UV-cable reel 300 m



Full extension PowerLIGHT Pro 18.000

## Truck installation - PowerLIGHT Pro



Workplace with drawers



Video workplace

## Truck installation - UV-technology



Work surface with power supply



Kitchen

# Installation – Rehabilitation technology

Impressions vehicle installation



# Liner installation



Calibration / impregnation system with documentation



Liner calibration unit



# Rehabilitation technology



Calibration / impregnation system with documentation



Calibration system side view

# Rehabilitation technology



Glass rolls



Calibration unit front view

# Trailer installation



Individual installation with THP-System



View inside the trailer

## Trailer installation



Individual installation with Power Box



Individual installation with TOP HAT system

# Available for you

---

- + Always find the right contact person for your request
- + Use the online database or download the list of contact persons directly as a useful PDF file
- + The specialist departments Office, Sales & Service are always available for you during our opening hours
- + Requests by mail are processed within a maximum of 24 hours



## Order Center

+49 234 57988-60  
office@ist-web.com



## Sales

+49 234 57988-61  
sales@ist-web.com



## Service

+49 234 57988-62  
service@ist-web.com

# Follow us

---

- + You always want to stay up to date?  
Then follow us on our social media channels
- + Simply click on the button and network directly



# Thanks for your attention

---

**I.S.T. Innovative Sewer Technologies GmbH**

Rombacher Hütte 19  
44795 Bochum

Phone +49 234 57988-0

Fax +49 234 57988-55

info@ist-web.com

www.ist-web.com



**Discover our current  
product catalog**  
[Browse online now](#)

